

CVV



Screw-to-connect couplings, ISO 14541 interchange.

Screw-on couplings suitable for general purpose applications. Connectable under residual pressure. High resistance to pressure and flow impulses. Interchangeable according to ISO 14541 standard for size: 1/4"; 3/8"; 1/2"; 3/4".



Applications

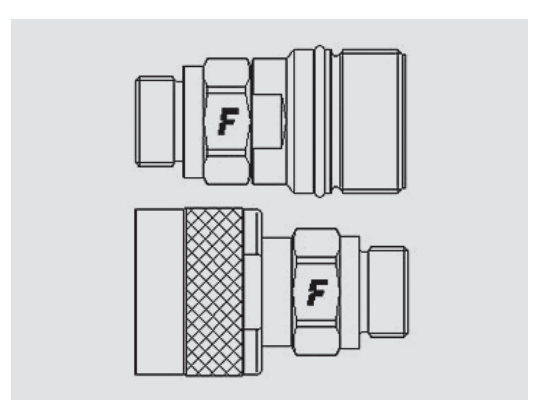

Technical Specifications

dash	Size		Working Pressure* (MPa)	Flow Rate (l/min)	Spillage (ml)	Force to Connect (N)	Burst pressure (MPa)		
	mm	inch					Male	Female	Male + Female
04	6,3	1/4"	37	13	0,8	0	150	160	190
06	10	3/8"	30	25	1,3	0	120	130	170
08	12,5	1/2"	30	65	1,8	0	120	140	140
12	20	3/4"	27	100	8	0	110	120	130
16	25	1"	27	205	13	0	110	130	140
24	37,5	1-1/2"	27	450	34	0	110	110	100

* Working Pressure according to ISO 14541, that requires a safety factor 4:1 on Minimum Burst Pressure. The coupling can perfectly work with a safety factor 3:1 and consequently with higher Working Pressure.

Material	Steel
Seals	NBR; VITON**
Working temperatures	- 25 °C to + 125 °C
Surface treatment	MATE 500 (CrIII)
Series Interchange	MARKET; ISO 14541
Valve Type	Poppet
Connection	Screw to Connect
Disconnection	Unscrew to Disconnect
Connection Under Pressure	Allowed Residual

** Working temperatures: - 20 °C to + 200 °C

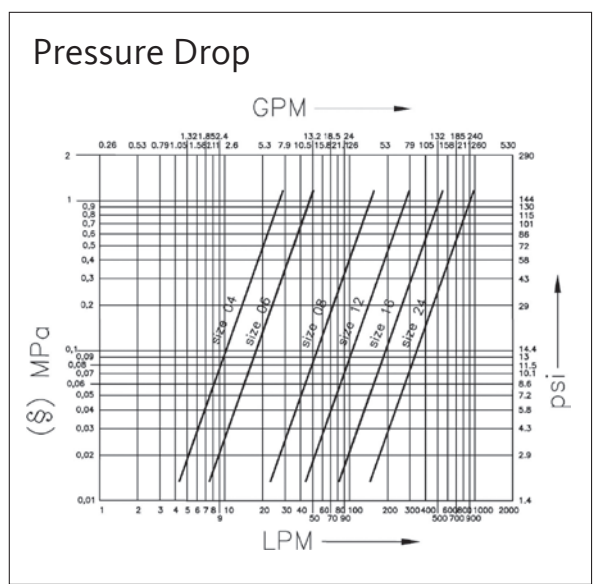

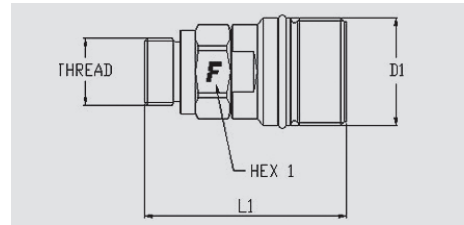

Size		Thread details			FEMALE						
inch	mm	Thread Type	Standard	Thread	Part Number	L (L1 + Thread)		D1		HEX1	
						mm	inch	mm	inch	mm	inch
1/4"	6,3	07/ METRIC	ISO 8434-1-L	M12x1,5 MALE BULKHEAD SHORT 6L	CVV047/1215 F	74	2,91	24	0,94	19	0,75
1/4"	6,3	07/ METRIC	ISO 8434-1-L	M14x1,5 MALE BULKHEAD SHORT 8L	CVV047/1415 F	74	2,91	24	0,94	19	0,75
1/4"	6,3	07/ METRIC	ISO 8434-1-L	M18x1.5 MALE BULKHEAD SHORT 12L	CVV047/1815 F	74	2,91	24	0,94	22	0,87
1/4"	6,3	12/ SAE	ISO 8434-3	13/16"-16 UN MALE BULKHEAD ORFS	CVV0412/12S F	82,5	3,25	24	0,94	24	0,94
1/4"	6,3	27/ SAE	ISO 8434-3	9/16"-18 UNF FEMALE ORFS	CVV0427/14SAEF	62	2,44	24	0,94	19	0,75
1/4"	6,3	F BSPP	ISO 1179-1	BSPP 1/4 FEMALE	CVV04 14 GAS F	63	2,48	24	0,94	19	0,75
3/8"	10	02/ METRIC	ISO 8434-1-L	M16x1,5 MALE 10L	CVV062/1615 F	68	2,68	28	1,1	24	0,94
3/8"	10	05/ METRIC	ISO 8434-1-L	M16x1,5 MALE BULKHEAD 10L	CVV065/1615 F	92	3,62	28	1,1	24	0,94
3/8"	10	07/ METRIC	ISO 8434-1-L	M18x1.5 MALE BULKHEAD SHORT 12L	CVV067/1815 F	83	3,27	28	1,1	24	0,94
3/8"	10	F BSPP	ISO 1179-1	BSPP 3/8 FEMALE	CVV06 38 GAS F	71	2,8	28	1,1	24	0,94
1/2"	12,5	0/ BSPP	BS 5380	BSPP 1/2 FEMALE ORB	CVV080/12GAS FV	61	2,4	36	1,42	27	1,06
1/2"	12,5	0/ BSPP	BS 5380	BSPP 3/8 FEMALE ORB	CVV080/38GAS FV	57	2,24	36	1,42	27	1,06
1/2"	12,5	0/ METRIC	ISO 6149-1	M22x1,5 FEMALE ORB	CVV080/2215 FV	61	2,4	36	1,42	27	1,06
1/2"	12,5	0/ SAE	ISO 11926-1	3/4"-16 UNF FEMALE ORB	CVV080/12SAE FV	61	2,4	36	1,42	27	1,06
1/2"	12,5	02/ METRIC	ISO 8434-1-L	M16x1,5 MALE 10L	CVV082/1615 FV	59	2,32	36	1,42	27	1,06
1/2"	12,5	02/ METRIC	ISO 8434-1-L	M18x1,5 MALE 12L	CVV082/1815 FV	57	2,24	36	1,42	27	1,06
1/2"	12,5	02/ METRIC	ISO 8434-1-L	M22x1,5 MALE 15L	CVV082/2215 FV	58	2,28	36	1,42	27	1,06
1/2"	12,5	02/ METRIC	ISO 8434-1-L	M26x1,5 MALE 18L	CVV082/2615 FV	58	2,28	36	1,42	27	1,06
1/2"	12,5	03/ METRIC	ISO 8434-1-S	M20x1.5 MALE 12S	CVV083/2015 FV	58	2,28	36	1,42	27	1,06
1/2"	12,5	03/ METRIC	ISO 8434-1-S	M22x1.5 MALE 14S	CVV083/2215 FV	60	2,36	36	1,42	27	1,06
1/2"	12,5	03/ METRIC	ISO 8434-1-S	M24x1,5 MALE 16S	CVV083/2415 FV	60	2,36	36	1,42	27	1,06
1/2"	12,5	05/ METRIC	ISO 8434-1-L	M16x1,5 MALE BULKHEAD 10L	CVV085/1615 FV	81	3,19	36	1,42	27	1,06
1/2"	12,5	05/ METRIC	ISO 8434-1-L	M18x1,5 MALE BULKHEAD 12L	CVV085/1815 FV	81	3,19	36	1,42	27	1,06
1/2"	12,5	05/ METRIC	ISO 8434-1-L	M22x1,5 MALE BULKHEAD 15L	CVV085/2215 FV	81	3,19	36	1,42	27	1,06
1/2"	12,5	05/ METRIC	ISO 8434-1-L	M26x1,5 MALE BULKHEAD 18L	CVV085/2615 FV	81	3,19	40	1,57	27	1,06
1/2"	12,5	06/ METRIC	ISO 8434-1-S	M24x1.5 MALE BULKHEAD 16S	CVV086/2415 FV	81	3,19	36	1,42	27	1,06
1/2"	12,5	07/ METRIC	ISO 8434-1-L	M18x1.5 MALE BULKHEAD SHORT 12L	CVV087/1815 FV	72	2,83	36	1,42	27	1,06
1/2"	12,5	07/ METRIC	ISO 8434-1-L	M22x1.5 MALE BULKHEAD SHORT 15L	CVV087/2215 FV	72	2,83	36	1,42	27	1,06
1/2"	12,5	27/ SAE	ISO 8434-3	1"-14 UNS FEMALE ORFS	CVV0827/58SAEFV	64	2,52	36	1,42	30	1,18
1/2"	12,5	F BSPP	ISO 1179-1	BSPP 1/2 FEMALE	CVV08 12 GAS FV	61	2,4	36	1,42	27	1,06
1/2"	12,5	F BSPP	ISO 1179-1	BSPP 3/8 FEMALE	CVV08 38 GAS FV	57	2,24	36	1,42	27	1,06

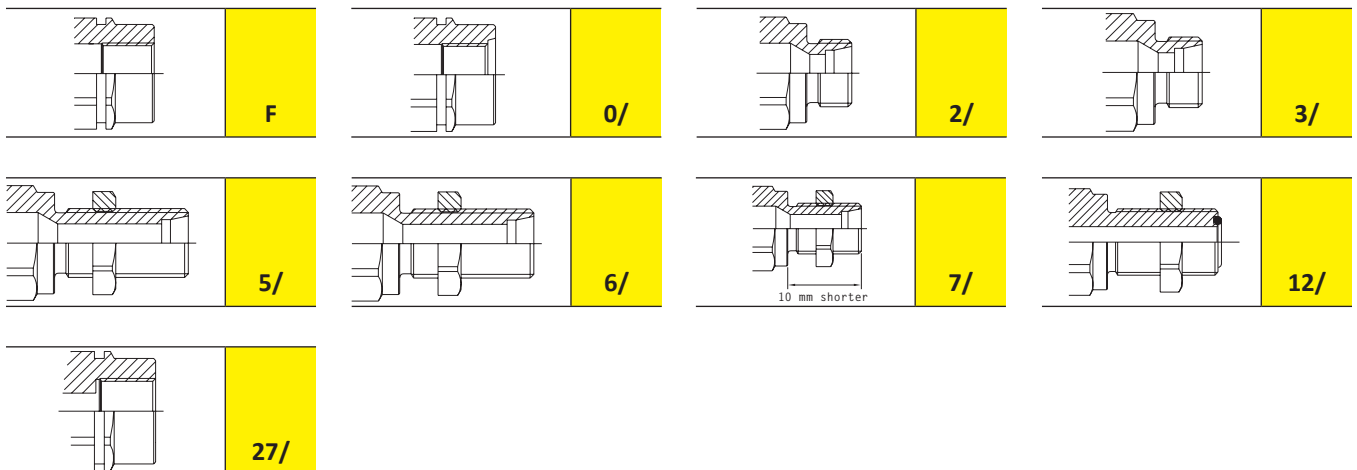

CVV

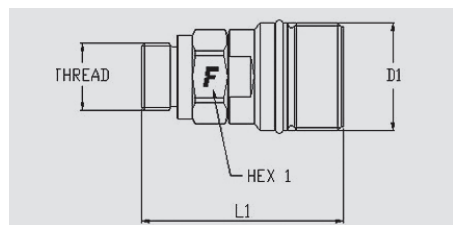

Size		Thread details			FEMALE						
inch	mm	Thread Type	Standard	Thread	Part Number	L (L1 + Thread)		D1		HEX1	
						mm	inch	mm	inch	mm	inch
3/4"	20	O/ SAE	ISO 11926-1	1-1/16"-12 UN FEMALE ORB	CVV120/34SAE FV	83	3,27	42	1,65	38	1,5
3/4"	20	F BSPP	ISO 1179-1	BSPP 3/4 FEMALE	CVV12 34 GAS FV	83	3,27	42	1,65	38	1,5
1"	25	O/ BSPP	BS 5380	BSPP 1 FEMALE ORB	CVV160/1GAS FV	93	3,66	48	1,89	42	1,65
1"	25	O/ BSPP	BS 5380	BSPP 3/4 FEMALE ORB	CVV160/34GAS FV	90	3,54	48	1,89	38	1,5
1"	25	O2/ METRIC	ISO 8434-1-L	M36x2 MALE 28L	CVV162/362 F V	87	3,43	48	1,89	38	1,5
1"	25	O3/ METRIC	ISO 8434-1-S	M30x2 MALE 20S	CVV163/302 F V	92	3,62	48	1,89	38	1,5
1"	25	O3/ METRIC	ISO 8434-1-S	M36x2 MALE 25S	CVV163/362 F V	93	3,66	48	1,89	38	1,5
1"	25	O3/ METRIC	ISO 8434-1-S	M42x2 MALE 30S	CVV163/422 F V	90	3,54	51	2,01	46	1,81
1"	25	O5/ METRIC	ISO 8434-1-L	M26x1,5 MALE BULKHEAD 18L	CVV165/2615 FV	116	4,57	48	1,89	38	1,5
1"	25	O5/ METRIC	ISO 8434-1-L	M30x2 MALE BULKHEAD 22L	CVV165/302 F V	109	4,29	48	1,89	41	1,61
1"	25	O5/ METRIC	ISO 8434-1-L	M36x2 MALE BULKHEAD 28L	CVV165/362 F V	106	4,17	52	2,05	42	1,65
1"	25	O6/ METRIC	ISO 8434-1-S	M30x2 MALE BULKHEAD 20S	CVV166/302 F V	114	4,49	48	1,89	38	1,5
1"	25	O6/ METRIC	ISO 8434-1-S	M36x2 MALE BULKHEAD 25S	CVV166/362 F V	113	4,45	52	2,05	42	1,65
1"	25	O6/ METRIC	ISO 8434-1-S	M42x2 MALE BULKHEAD 30S	CVV166/422 F V	110	4,33	56	2,2	50	1,97
1"	25	11/ SAE	ISO 8434-3	1-11/16"-12 UN MALE ORFS	CVV1611/114S FV	96	3,78	55	2,17	50	1,97
1"	25	11/ SAE	ISO 8434-3	1-7/16"-12 UN MALE ORFS	CVV1611/1SAE FV	96	3,78	55	2,17	50	1,97
1"	25	F BSPP	ISO 1179-1	BSPP 1 FEMALE	CVV16 1 GAS FV	94	3,7	46	1,81	42	1,65
1"	25	F BSPP	ISO 1179-1	BSPP 3/4 FEMALE	CVV16 34 GAS FV	89	3,5	48	1,89	38	1,5
1-1/2"	37,5	O2/ METRIC	ISO 8434-1-L	M45x2 MALE 35L	CVV242/452 F V	111	4,37	70	2,76	55	2,17
1-1/2"	37,5	O3/ METRIC	ISO 8434-1-S	M42x2 MALE 30S	CVV243/422 F V	115	4,53	70	2,76	55	2,17
1-1/2"	37,5	O3/ METRIC	ISO 8434-1-S	M52x2 MALE 38S	CVV243/522 F V	117	4,61	70	2,76	55	2,17
1-1/2"	37,5	O5/ METRIC	ISO 8434-1-L	M45x2 MALE BULKHEAD 35L	CVV245/452 F V	131	5,16	70	2,76	55	2,17
1-1/2"	37,5	O6/ METRIC	ISO 8434-1-S	M42x2 MALE BULKHEAD 30S	CVV246/422 F V	135	5,31	70	2,76	55	2,17
1-1/2"	37,5	O6/ METRIC	ISO 8434-1-S	M52x2 MALE BULKHEAD 38S	CVV246/522 F V	137	5,39	73	2,87	55	2,17
1-1/2"	37,5	F BSPP	ISO 1179-1	BSPP 1-1/2 FEMALE	CVV24 112GAS FV	121	4,76	72	2,83	65	2,56

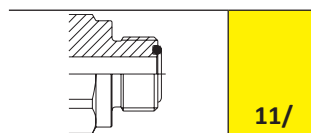
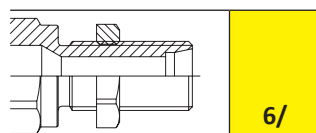
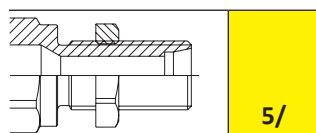
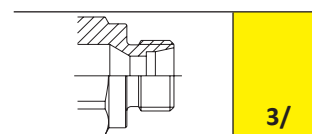
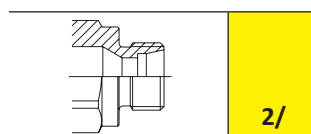
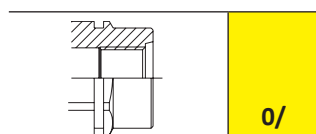
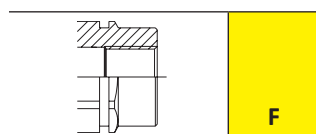

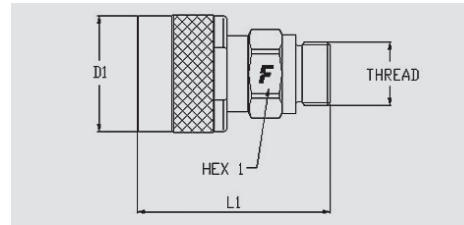

Size		Thread details			MALE								
inch	mm	Thread Type	Standard	Thread	Part Number	L (L1 + Thread)		D1		D3		HEX1	
						mm	inch	mm	inch	mm	inch	mm	inch
1/4"	6,3	02/ METRIC	ISO 8434-1-L	M12x1,5 MALE 6L	CVV042/1215 M	58	2,28	30	1,18			19	0,75
1/4"	6,3	02/ METRIC	ISO 8434-1-L	M14x1,5 MALE 8L	CVV042/1415 M	58	2,28	30	1,18			19	0,75
1/4"	6,3	02/ METRIC	ISO 8434-1-L	M18x1,5 MALE 12L	CVV042/1815 M	59	2,32	30	1,18			22	0,87
1/4"	6,3	11/ SAE	ISO 8434-3	13/16"-16 UN MALE ORFS	CVV0411/12S M	61	2,4	30	1,18			22	0,87
1/4"	6,3	27/ SAE	ISO 8434-3	9/16"-18 UNF FEMALE ORFS	CVV0427/14SAEM	62	2,44	30	1,18			19	0,75
1/4"	6,3	F BSPP	ISO 1179-1	BSPP 1/4 FEMALE	CVV04 14 GAS M	63	2,48	30	1,18			19	0,75
3/8"	10	02/ METRIC	ISO 8434-1-L	M16x1,5 MALE 10L	CVV062/1615 M	66	2,6	34	1,34			24	0,94
3/8"	10	02/ METRIC	ISO 8434-1-L	M18x1,5 MALE 12L	CVV062/1815 M	68	2,68	34	1,34			24	0,94
3/8"	10	F BSPP	ISO 1179-1	BSPP 3/8 FEMALE	CVV06 38 GAS M	70	2,76	34	1,34			24	0,94
1/2"	12,5	0/ BSPP	BS 5380	BSPP 1/2 FEMALE ORB	CVV080/12GAS MV	70	2,76	42	1,65			27	1,06
1/2"	12,5	0/ BSPP	BS 5380	BSPP 3/8 FEMALE ORB	CVV080/38GAS MV	66	2,6	42	1,65			27	1,06
1/2"	12,5	0/ METRIC	ISO 6149-1	M22x1,5 FEMALE ORB	CVV080/2215 MV	70	2,76	42	1,65			27	1,06
1/2"	12,5	0/ SAE	ISO 11926-1	3/4"-16 UNF FEMALE ORB	CVV080/12SAE MV	70	2,76	42	1,65			27	1,06
1/2"	12,5	02/ METRIC	ISO 8434-1-L	M16x1,5 MALE 10L	CVV082/1615 MV	67	2,64	42	1,65			27	1,06
1/2"	12,5	02/ METRIC	ISO 8434-1-L	M18x1,5 MALE 12L	CVV082/1815 MV	66	2,6	42	1,65			27	1,06
1/2"	12,5	02/ METRIC	ISO 8434-1-L	M22x1,5 MALE 15L	CVV082/2215 MV	67	2,64	42	1,65			27	1,06
1/2"	12,5	02/ METRIC	ISO 8434-1-L	M26x1,5 MALE 18L	CVV082/2615 MV	67	2,64	42	1,65			27	1,06
1/2"	12,5	03/ METRIC	ISO 8434-1-S	M20x1.5 MALE 12S	CVV083/2015 MV	67	2,64	42	1,65			27	1,06
1/2"	12,5	03/ METRIC	ISO 8434-1-S	M22x1.5 MALE 14S	CVV083/2215 MV	69	2,72	42	1,65			27	1,06
1/2"	12,5	03/ METRIC	ISO 8434-1-S	M24x1,5 MALE 16S	CVV083/2415 MV	69	2,72	42	1,65			27	1,06
1/2"	12,5	05/ METRIC	ISO 8434-1-L	M18x1,5 MALE BULKHEAD 12L	CVV085/1815 MV	90	3,54	42	1,65			27	1,06
1/2"	12,5	05/ METRIC	ISO 8434-1-L	M22x1,5 MALE BULKHEAD 15L	CVV085/2215 MV	90	3,54	42	1,65			27	1,06
1/2"	12,5	06/ METRIC	ISO 8434-1-S	M22x1.5 MALE BULKHEAD 14S	CVV086/2215 MV	90	3,54	42	1,65			27	1,06
1/2"	12,5	06/ METRIC	ISO 8434-1-S	M24x1.5 MALE BULKHEAD 16S	CVV086/2415 MV	90	3,54	42	1,65			27	1,06
1/2"	12,5	07/ METRIC	ISO 8434-1-L	M18x1.5 MALE BULKHEAD SHORT 12L	CVV087/1815 MV	81	3,19	42	1,65			27	1,06
1/2"	12,5	07/ METRIC	ISO 8434-1-L	M22x1.5 MALE BULKHEAD SHORT 15L	CVV087/2215 MV	81	3,19	42	1,65			27	1,06
1/2"	12,5	27/ SAE	ISO 8434-3	1"-14 UNS FEMALE ORFS	CVV0827/58SAEMV	73	2,87	42	1,65			30	1,18

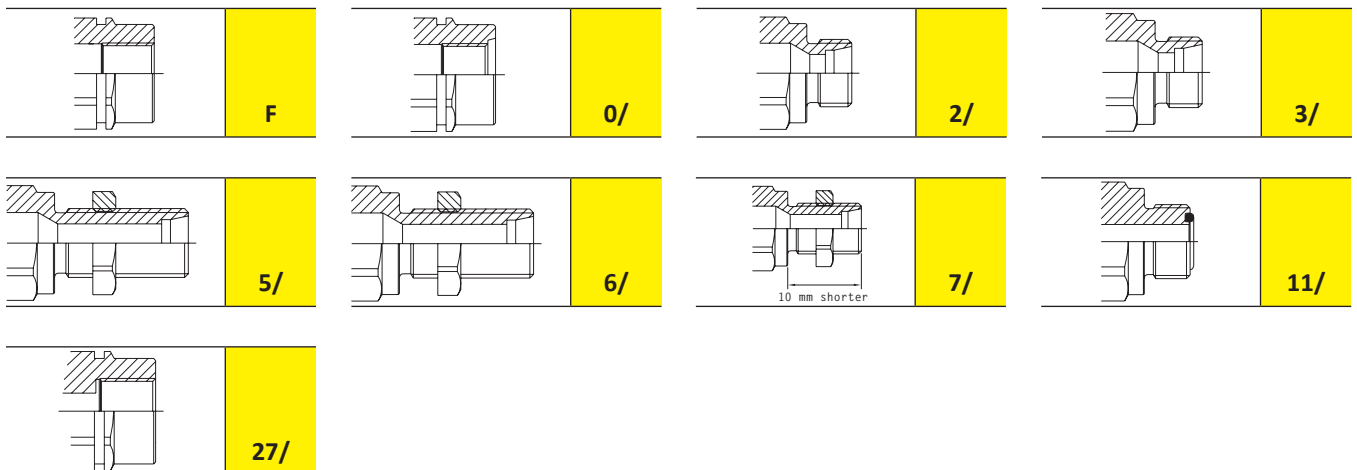

CVV

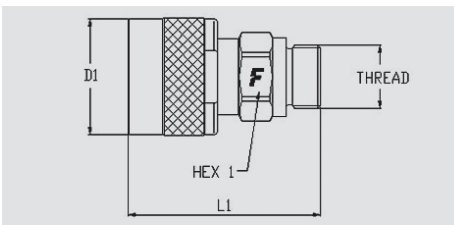

Size		Thread details			MALE								
inch	mm	Thread Type	Standard	Thread	Part Number	L (L1 + Thread)		D1		D3		HEX1	
						mm	inch	mm	inch	mm	inch	mm	inch
1/2"	12,5	F BSPP	ISO 1179-1	BSPP 1/2 FEMALE	CVV08 12 GAS MV	70	2,76	42	1,65			27	1,06
1/2"	12,5	F BSPP	ISO 1179-1	BSPP 3/8 FEMALE	CVV08 38 GAS MV	66	2,6	42	1,65			27	1,06
3/4"	20	O/ SAE	ISO 11926-1	1-1/16"-12 UN FEMALE ORB	CVV120/34SAE MV	86	3,39	48	1,89			38	1,5
3/4"	20	F BSPP	ISO 1179-1	BSPP 3/4 FEMALE	CVV12 34 GAS MV	86	3,39	48	1,89			38	1,5
1"	25	O/ BSPP	BS 5380	BSPP 1 FEMALE ORB	CVV160/1GAS MV	49	1,93	56	2,2			42	1,65
1"	25	O/ BSPP	BS 5380	BSPP 3/4 FEMALE ORB	CVV160/34GAS MV	90	3,54	56	2,2			38	1,5
1"	25	O/ SAE	ISO 11926-1	1-3/16"-12 UN FEMALE ORB	CVV16 78S M V	93	3,66	56	2,2			42	1,65
1"	25	O2/ METRIC	ISO 8434-1-L	M30x2 MALE 22L	CVV162/302 M V	89	3,5	56	2,2			38	1,5
1"	25	O2/ METRIC	ISO 8434-1-L	M36x2 MALE 28L	CVV162/362 M V	88	3,46	56	2,2			38	1,5
1"	25	O3/ METRIC	ISO 8434-1-S	M30x2 MALE 20S	CVV163/302 M V	93	3,66	56	2,2			38	1,5
1"	25	O3/ METRIC	ISO 8434-1-S	M36x2 MALE 25S	CVV163/362 M V	93	3,66	56	2,2			38	1,5
1"	25	O3/ METRIC	ISO 8434-1-S	M42x2 MALE 30S	CVV163/422 M V	90	3,54	56	2,2			38	1,5
1"	25	O5/ METRIC	ISO 8434-1-L	M36x2 MALE BULKHEAD 28L	CVV165/362 M V	107	4,21	56	2,2			42	1,65
1"	25	O6/ METRIC	ISO 8434-1-S	M30x2 MALE BULKHEAD 20S	CVV166/302 M V	115	4,53	56	2,2			38	1,5
1"	25	O6/ METRIC	ISO 8434-1-S	M36x2 MALE BULKHEAD 25S	CVV166/362 M V	113	4,45	56	2,2			42	1,65
1"	25	O6/ METRIC	ISO 8434-1-S	M42x2 MALE BULKHEAD 30S	CVV166/422 M V	110	4,33	56	2,2			50	1,97
1"	25	O11/ SAE	ISO 8434-3	1-11/16"-12 UN MALE ORFS	CVV1611/114S MV	97	3,82	56	2,2			50	1,97
1"	25	O11/ SAE	ISO 8434-3	1-7/16"-12 UN MALE ORFS	CVV1611/1SAE MV	97	3,82	56	2,2			50	1,97
1"	25	F BSPP	ISO 1179-1	BSPP 1 FEMALE	CVV16 1 GAS MV	95	3,74	56	2,2			42	1,65
1"	25	F BSPP	ISO 1179-1	BSPP 3/4 FEMALE	CVV16 34 GAS MV	90	3,54	56	2,2			38	1,5
1-1/2"	37,5	O3/ METRIC	ISO 8434-1-S	M42x2 MALE 30S	CVV243/422 M V	125	4,92	80	3,15			55	2,17
1-1/2"	37,5	O3/ METRIC	ISO 8434-1-S	M52x2 MALE 38S	CVV243/522 M V	127	5	80	3,15			55	2,17
1-1/2"	37,5	O6/ METRIC	ISO 8434-1-S	M52x2 MALE BULKHEAD 38S	CVV246/522 M V	147	5,79	80	3,15			55	2,17
1-1/2"	37,5	F BSPP	ISO 1179-1	BSPP 1-1/2 FEMALE	CVV24 112GAS MV	131	5,16	80	3,15			65	2,56

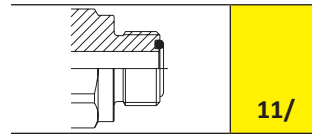
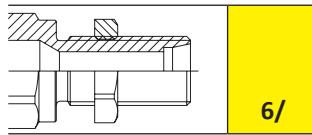
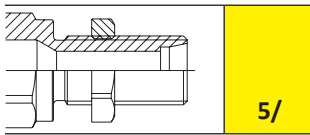
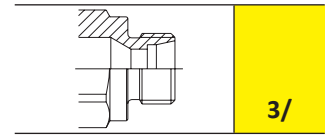
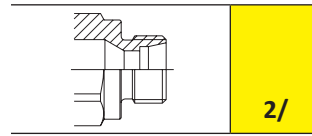
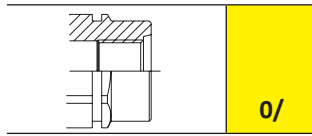
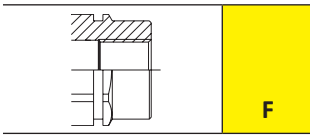

CVV accessories

Plastic dust caps



Caps suitable for FEMALE



Plugs suitable for MALE

Size			Cap Details		Size			Plug Details	
inch	mm	dash	Part number	Colour	inch	mm	dash	Part number	Colour
1/4"	6,3	04	TMVV 04	red	1/4"	6,3	04	TFVV 04	red
3/8"	10	06	TMVV 06	red	3/8"	10	06	TFVV 06	red
1/2"	12,5	08	TMVV 08	red	1/2"	12,5	08	TFVV 08	red
3/4"	20	12	TMVV 12	red	3/4"	20	12	TFVV 12	red
1"	25	16	TMVV 16	red	1"	25	16	TFVV 16	red
1-1/2"	37,5	24	TMVV 24	red	1-1/2"	37,5	24	TFVV 24	red

Aluminium dust caps



Caps suitable for FEMALE

Caps suitable for MALE

Size			Cap Details		Size			Cap Details	
inch	mm	dash	Part number	Colour	inch	mm	dash	Part number	Colour
1/4"	6,3	04	TMVV 04 S		1/4"	6,3	04	TFVV 04 S	
3/8"	10	06	TMVV 06 S		3/8"	10	06	TFVV 06 S	
1/2"	12,5	08	TMVV 08 S		1/2"	12,5	08	TFVV 08 S	
1"	25	16	TMVV 16 S		1"	25	16	TFVV 16 S	
1-1/2"	37,5	24	TMVV 24 S		1-1/2"	37,5	24	TFVV 24 S	

Seal Kits



For Female

Size			Seal Details	
inch	mm	dash	Material	Part Number
1/4"	3,2	04	NBR; PTFE	SK CVV 04
3/8"	10	06	NBR; PTFE	SK CVV 06
1/2"	12,5	08	FKM; PTFE	SK CVV 08 V
3/4"	20	12	FKM; PTFE	SK CVV 12 V
1"	25	16	FKM; PTFE	SK CVV 16 V
1-1/2"	37,5	24	FKM; PTFE	SK CVV 24 V

Every seals kit is composed of 5 or 10 pcs.